

## Hand Operated Curtain Track System

# Silent Gliss® 6870

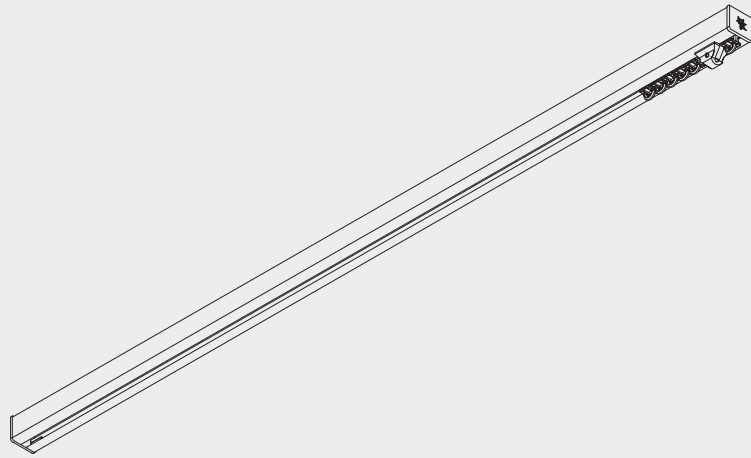

### Product Information

- Operation: hand drawn
- Range: M
- Fitting: ceiling, wall, recess
- Colours: white, matt white, silver anodised, anodic grey, charcoal and antique bronze
- Square shaped design
- 2C glider technology
- Wave compatible
- Bendable (including recess profile)



6870

[www.shadingspecialist.co.uk](http://www.shadingspecialist.co.uk)

## Profile and Bending Information

### Profile

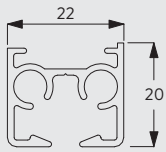

11190

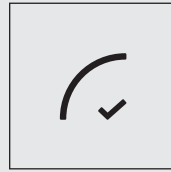

Radius: >26 cm

### Recess profile

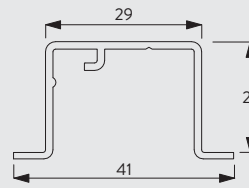

11230

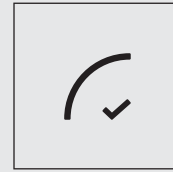

Radius: >50 cm

## How To Measure

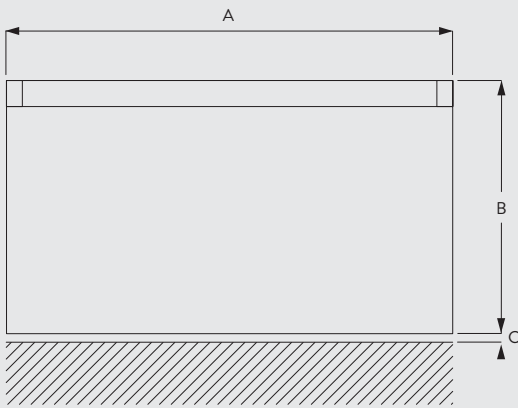

A: System width  
B: System height  
C: Distance between floor and fabric

## System Options

### Wave Curtain Heading System

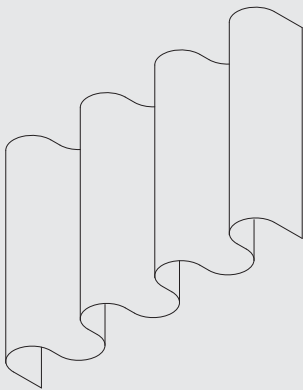

6870

The Wave standard components are:

- 11303 Wave 2C Glider Cord 60mm
- 11302 Wave 2C Glider Cord 80mm
- 6007 End stop
- 6315 Pilot runner

The items listed below for Enhanced Wave (80mm glider cord only) are all supplied at an additional cost as per the price list.

- 2255 Adjustable brake
- 6364 Extension (used with 6365)
- 6365 Hanger (used with 6364)
- 6366 Carrier for draw rod

Roller Gliders must be ordered separately  
6099 Wave roller glider 80mm

Optional components to improve the presentation of the curtain:

- 3582 Hook
- 6349 Curtain tape
- 6363 Iron-on top hemming tape
- 10075 Lead weight for hem of curtain 50gr/m
- 10076 Fabric weight for side edge of curtain

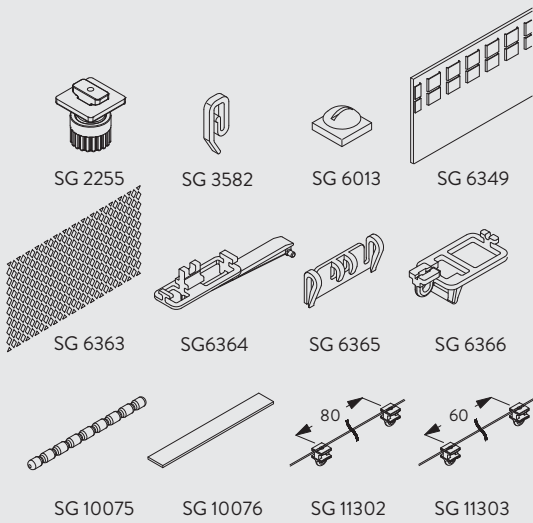

## Fitting Information

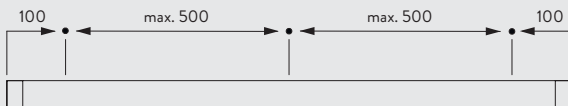

## Fitting Options

### Ceiling fitting with clamp SG 3825

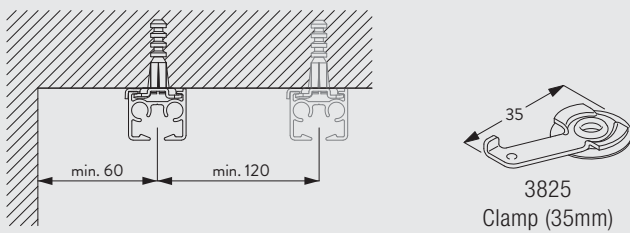

### Ceiling fitting with bracket SG 3826

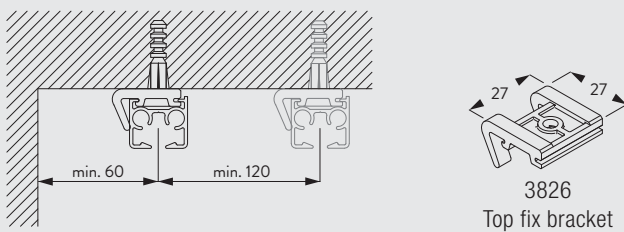

6870

### Ceiling fitting with bracket SG 3832

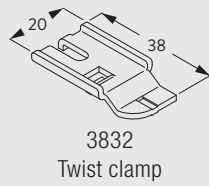
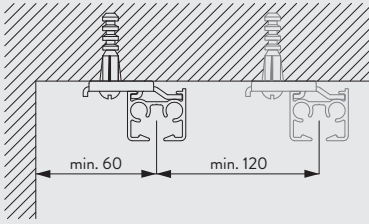

### Wall fitting with Smart Fix SG 11200-11205 and bracket SG 3826

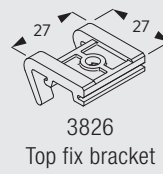
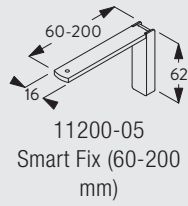
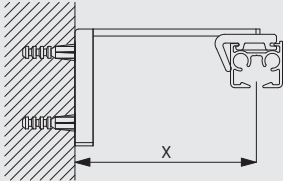

Brackets threaded for screw M4 x 8

### Wall fitting with Square Smart Fix SG 11210-11215 and bracket SG 3826

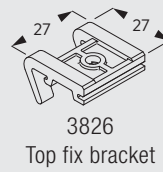
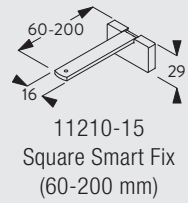
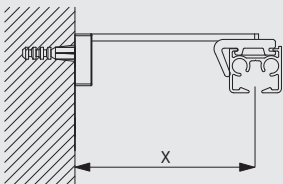

Brackets threaded for screw M4 x 8

### Wall fitting with Universal Smart Fix SG 11154-11156 and bracket SG 3826

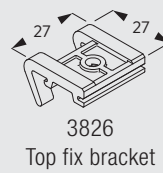
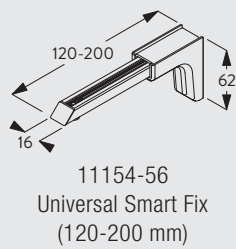
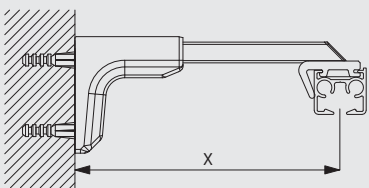

Brackets threaded for screw M4 x 8

Wall fitting with Smart Fix SG 11200-11205 and bracket SG 3832

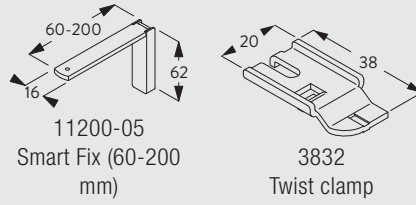
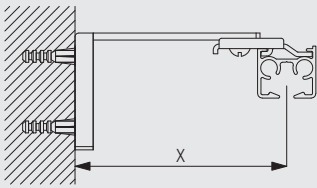

Brackets threaded for screw M4 x 8

Wall fitting with Square Smart Fix SG 11210-11215 and bracket SG 3832

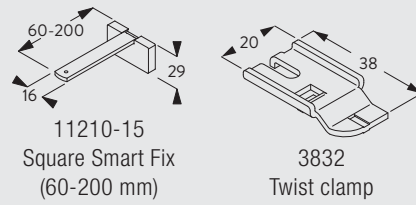
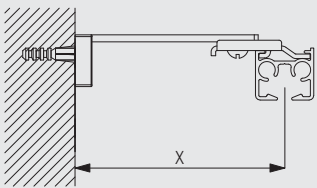

Brackets threaded for screw M4 x 8

Wall fitting with Universal Smart Fix SG 11154-11156 and bracket SG 3832

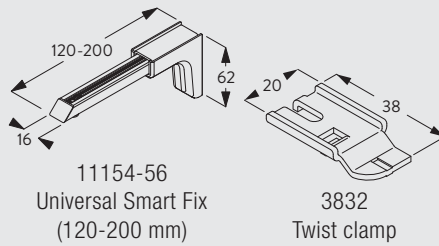
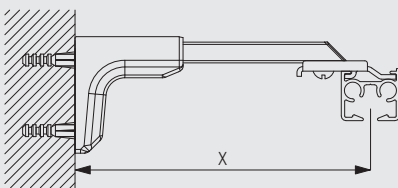

Brackets threaded for screw M4 x 8

Wall fitting with bracket SG 3836

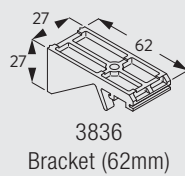
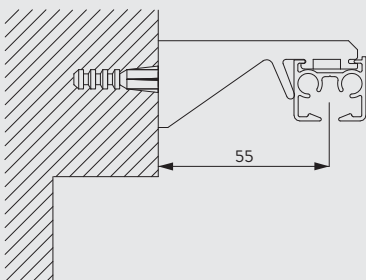

## Recess fitting with recess profile SG 11230

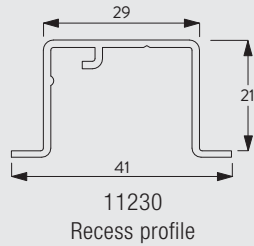
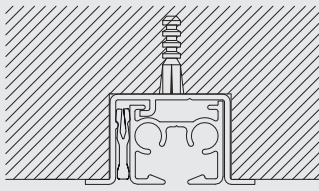

### Standard Accessories

3825 Clamp (35mm)



6065 Twist eye endstop



11190 Profile



11233 End cover



11301 2C glider on strip



### Optional Accessories

3582 Hook



3599 Hook



3802 Connecting bridge

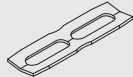

3826 Top fix bracket

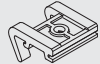

3832 Twist clamp

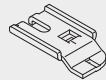

3836 Bracket (62mm)

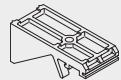

6007 Endstop



6053 Spring stop



6064 Screw twist endstop



6094 Roller glider with hook



6098 Roller glider with eye



6283 Roller glider



10157 Clamp



10407 Pan head screw M4x10



10430 Draw rod with hook, 50cm



10431 Draw rod with hook, 75cm

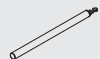

10432 Draw rod with hook, 100cm



10433 Draw rod with hook, 125cm









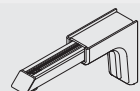

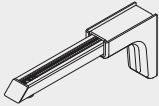
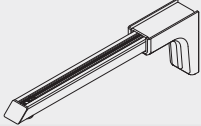

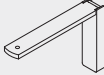
10434 Draw rod with hook, 150cm





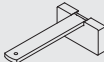
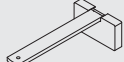
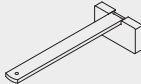
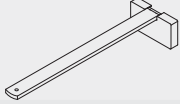
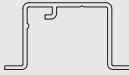



11154 Universal Smart Fix, 120 mm set

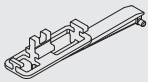

11155	Universal Smart Fix, 150 mm set		11156	Universal Smart Fix, 200 mm set	
11200	Smart Fix, 60 mm set		11201	Smart Fix, 80 mm set	
11202	Smart Fix, 100 mm set		11203	Smart Fix, 120 mm set	
11204	Smart Fix, 150 mm set		11205	Smart Fix, 200 mm set	
11210	Square Smart Fix, 60 mm set		11211	Square Smart Fix, 80 mm set	
11212	Square Smart Fix, 100 mm set		11213	Square Smart Fix, 120 mm set	
11214	Square Smart Fix, 150 mm set		11215	Square Smart Fix, 200 mm set	
11230	Recess profile		11238	Recess Mask	

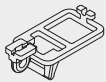
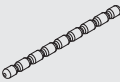
## Wave Accessories

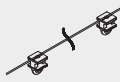
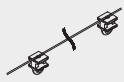
2255	Adjustable brake		6349	Curtain tape	
6363	Top hemming tape		6364	Extension	
6365	Hanger		6366	Wave carrier for draw rod	
10075	Lead weight 50 gr/m		10076	Fabric weight	
11302	Wave 2C glider cord 80 mm		11303	Wave 2C glider cord 60 mm	

6870