

# Cord/Wand operated Venetian Blind System

## Silent Gliss® 8110

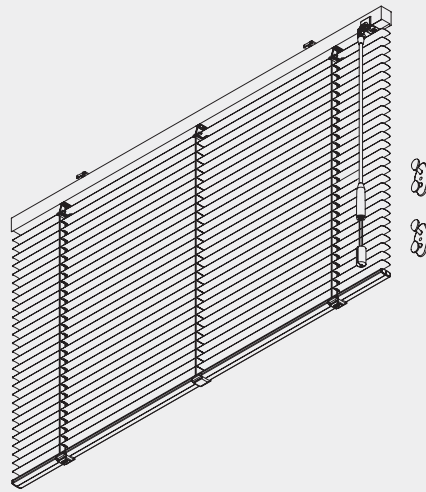

### Product Information

- Venetian blind system for 16mm or 25mm aluminium slats
- Unique user-friendly control wand, combining tilt operation of slats with integrated cords for fast raising/lowering of the blind
- Left or right hand operation with various wand lengths available
- Available in 77 different slat colours
- The system 8110 can be equipped with side-guide wires and can therefore be used for sloped applications up to 15° incline from vertical
- Privacy feature (PC) standard for 25 mm slats, where the slats are punched to ensure no direct light penetration when slats are closed. The 8110 system is therefore ideal for use in offices and helps compliance with EC computer shading regulations
- Integrated brake enables precise and controlled lowering of slats
- Click mechanism ensures slats snap into the closed position which avoids gradual reopening



8110

[www.shadingspecialists.co.uk](http://www.shadingspecialists.co.uk)

Shading Specialists  
Unit 23  
Orbital 25  
Dwight Road  
Watford  
WD18 9DA  
020 8421 6605

## Profile, Bending and Specification Information

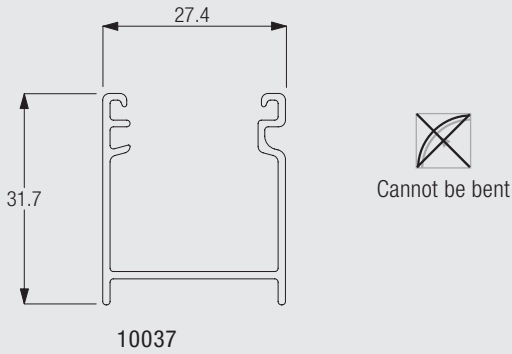

### Specification Information - download from [www.silentgliss.co.uk](http://www.silentgliss.co.uk) (password required).

Silent Gliss 8110 system wand control venetian blind. Overall width .....cm, overall drop .....cm. Dual operation with control wand and integral cord LHS / RHS. Slat colour(s) to be chosen from Silent Gliss 16mm or 25mm range. System is to be fixed with snap-on-brackets 10101 to ceiling / wall at 800-1000mm intervals plus one at 50mm from each end.

## System Dimensions and Slat Stack Height



2.5m (16mm slats)  
3m (25mm slats)



28cm (16 and 25mm slats)



2.5m (16mm slats)  
5m (25mm slats)



5m² (16mm slats)  
7m² (25mm slats)

### Slat stack height calculation

8110		mm	max.											(cm)
			50	75	100	125	150	175	200	225	250	275	300	
	16	X	6.1	7.0	7.9	8.8	9.7	10.6	11.5	12.4	13.3			
	25 (PC)	X	6.4	7.3	8.1	9.1	9.6	10.6	11.5	12.3	13.2	14.0	15.0	15.9

  

	mm	max.							(cm)
		350	375	400	425	450	475	500	
16	X								
25 (PC)	X	16.7	17.6	18.4	19.3	20.2	21.0	21.9	

Please note that the indicated stack heights may vary by up to 1cm.

## System Options

### “Privacy feature” (PC) standard for 25mm slats

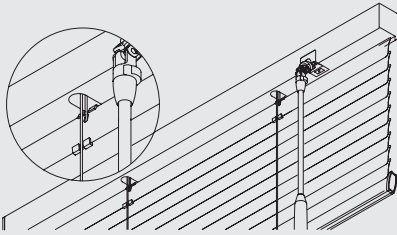

The slat holes are positioned to ensure no direct light penetration when slats are closed. The PC feature on 8110 is ideal for use in offices and helps compliance with EC computer shading regulations.

### Side guides for stabilising blind system and sloped applications (up to 15° from vertical)

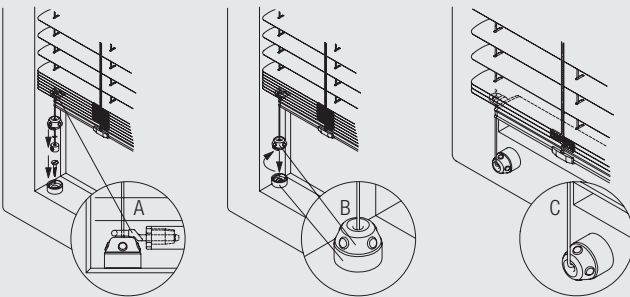

A and B: Fitting of side guides inside window frame  
 (A: detail eyelet / B: detail wireholder)  
 C: Fitting of side guides onto front of window frame

The system 8110 can be equipped with side-guide wires and can therefore also be used for sloped applications up to 15° incline from vertical.

## Fitting Information

### WARNING

Young children can be strangled by loops in pullcords, chains, tapes and inner cords that operate the product. To avoid strangulation and entanglement, keep cords out of the reach of young children. Cords may become wrapped around a child's neck. Move beds, cots and furniture away from window covering cords. Do not tie cords together. Make sure cords do not twist to create a loop.

### Bracket positioning

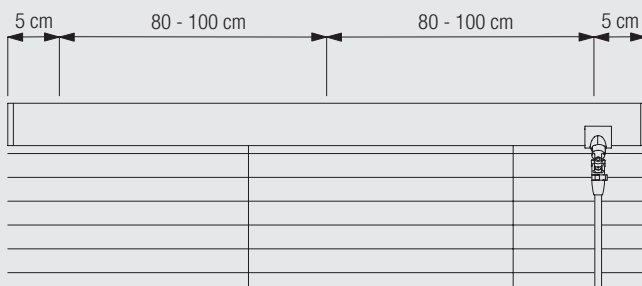

**Please note:** Cleats 10742 have to be installed at least 150cm above floor!



8110

## Side gaps when side-by-side fitting or recess fitting

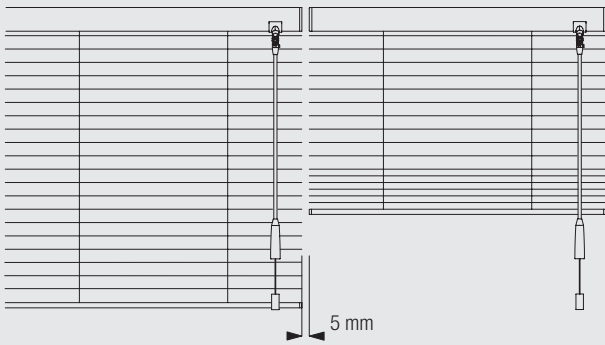

The light gap between two systems is 5mm when fitted side-by-side.

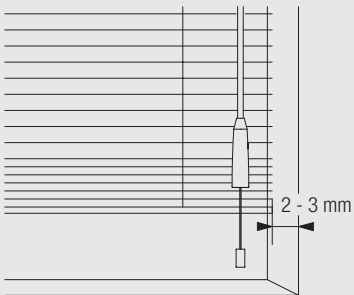

Distance from wall when recess fitting is 2-3mm.

## Fitting Options

### Ceiling fix with bracket 10101

8110

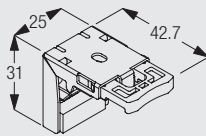
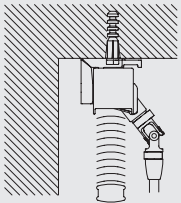

10101  
Bracket

### Recess fix with bracket 10101

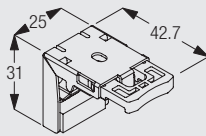
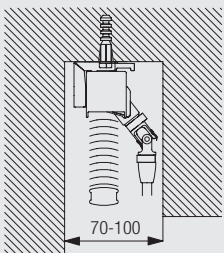

10101  
Bracket

### Wall or window frame fix with bracket 10101

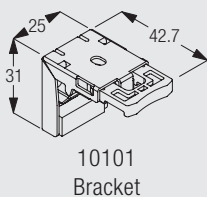
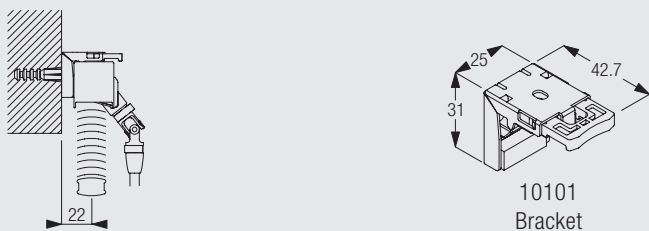

10101  
Bracket

### Wall fitting with Smart Fix 11200-11201 and bracket 10101

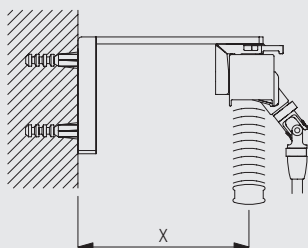

	X (mm)
11200	57-59
11201	77-79

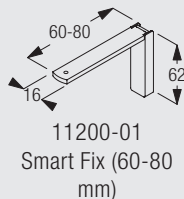

11200-01  
Smart Fix (60-80  
mm)

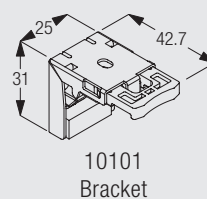

10101  
Bracket

Brackets feature thread for screw SG 10395 (M4x6) for fixing bracket SG 10101.

### Wall fitting with Square Smart Fix 11210-11211 and bracket 10101

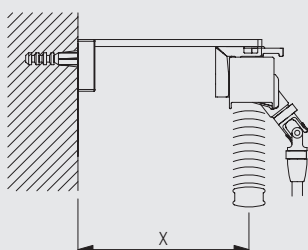

	X (mm)
11210	57-59
11211	77-79

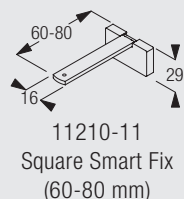

11210-11  
Square Smart Fix  
(60-80 mm)

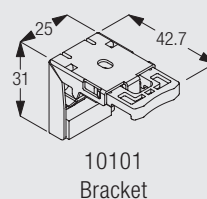

10101  
Bracket

Brackets feature thread for screw SG 10395 (M4x6) for fixing bracket SG 10101.

### Wall fitting with Universal Smart Fix 11154-11156 and bracket 10101

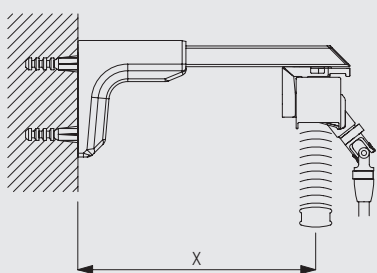

	X (mm)
11154	107-135
11155	137-165
11156	187-215

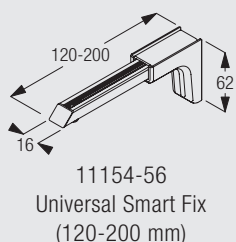

11154-56  
Universal Smart Fix  
(120-200 mm)

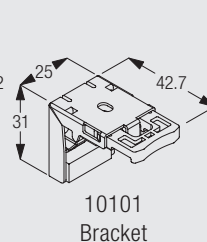

10101  
Bracket

Brackets feature thread for screw SG 10407 (M4x10) for fixing bracket SG 10101.



## Standard Accessories

8003 Bottom bar (16mm slats)







8004 Bottom bar (25mm slats)

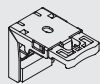
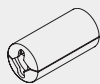



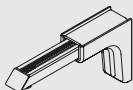
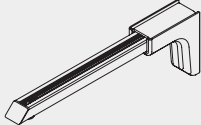

10037	Profile	
10742	Cleat	
10898	Eyelet	

10101	Bracket	
10748	Breakaway cord connector	

## Optional Accessories

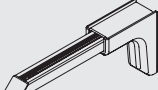
8235	Wire base short	
8237	Wire holder	
8249	Locking ring	
11154	Universal Smart Fix, 120 mm set	
11156	Universal Smart Fix, 200 mm set	
11201	Smart Fix, 80 mm set	
11211	Square Smart Fix, 80 mm set	

8236	Wire base long	
8241	Eyelet	
10120	Wire $\varnothing$ 0.9 mm for side guide	
11155	Universal Smart Fix, 150 mm set	
11200	Smart Fix, 60 mm set	
11210	Square Smart Fix, 60 mm set	



8110

## Useful Information

Control wands for the 8110 system are available in the following fixed lengths:  
35cm, 51cm, 71cm, 91cm, 111cm, 131cm, 151cm, 171cm, 193cm.  
When ordering, please specify the length you require.

## Useful Measures

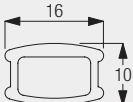
8003	Bottom bar (16mm slats)	
------	-------------------------	---

8004	Bottom bar (25mm slats)	
------	-------------------------	---