

## Hand Operated Curtain Track System

# Silent Gliss® 1200

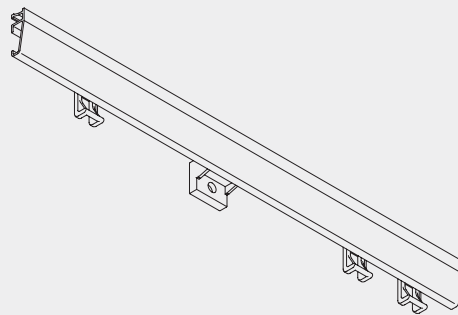

### Product Information

- Robust and versatile wall and ceiling fix hand operated curtain track
- For light to medium weight curtains
- Patented glider which glides on the profile edge, minimizing friction
- The quick-clip gliders 3933 can be easily added or removed without taking track down or apart
- Easy ceiling or wall fix to all surfaces
- Standard colour: white powder coated
- Metallic line colours available are silver anodised, black, anthracite, gunmetal, brushed aluminium and chrome effect
- Standard length of the profiles is 6m, with the exception of chrome, anthracite and brushed aluminium which are available in 4m lengths
- Can be bent



1200

[www.shadingspecialists.co.uk](http://www.shadingspecialists.co.uk)

Shading Specialists  
Unit 23  
Orbital 25  
Dwight Road  
Watford  
WD18 9DA  
020 8421 6605

[info@shadingspecialists.co.uk](mailto:info@shadingspecialists.co.uk)

## Profile, Bending and Specification Information

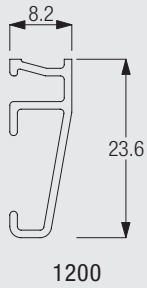

The standard radius is recommended for optimal operation.

**Specification Guide - download from [www.silentgliss.co.uk](http://www.silentgliss.co.uk) (password required).**

Silent Gliss 1200 hand drawn curtain track in white powder-coated aluminium. Fix to wall with brackets 3175/ceiling with brackets 3176 every 30-50cm. Special gliders should be fitted at 14/m to run on back rims of channel so as to keep curtain heading upright. Fit with end covers 3986 at either end.

## Fitting Information

### Bracket positioning and fixing with 3175 and 3176

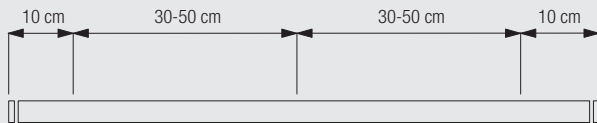

The fixing distances are meant as guide a only: they may vary in practice depending on surface or curtain weight.

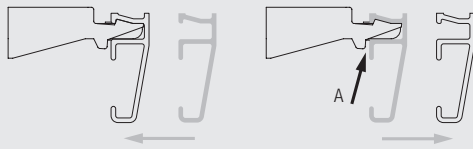

Installation: push track on bracket in direction indicated  
Removal: place screwdriver where indicated (A) and twist. Pull track away from bracket

1200

### Quick-clip glider 3933

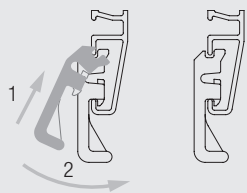

Easily clipped in and out of profile.

## Fitting Options



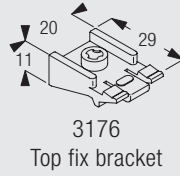
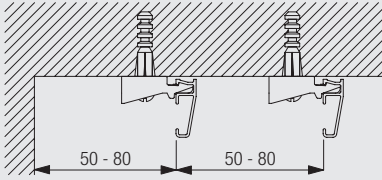

### Ceiling fix with bracket 3176

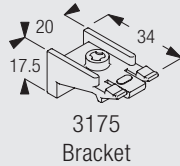
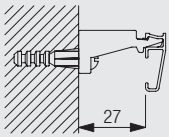

### Wall fix with bracket 3175











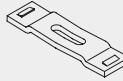
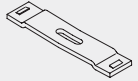

## Standard Accessories

			1200	Profile	
3175	Bracket		3933	Glider 3933 in strip form	
3986	Endcover (white, black, grey and dark grey)				



## Optional Accessories

3113	5cm spacer for double fixing		3115	7cm spacer for double fixing	
3176	Top fix bracket		3942	Endstop	
3945	Magnetic glider (part of set 3947)		3946	Magnetic glider (part of set 3947)	
10430	Draw rod with hook, 50cm		10431	Draw rod with hook, 75cm	
10432	Draw rod with hook, 100cm		10433	Draw rod with hook, 125cm	
10434	Draw rod with hook, 150cm				

## Useful Information and Sewing Accessories

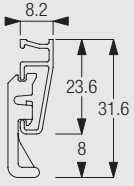
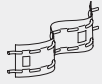

Diagram uses standard 3933 glider and is measured to the inside of the glider eye. For optional gliders substitute dimensions below:  
3945/3946 = 8mm

3562 Standard tape



3582 Hook



3599 Hook



1200



1200